

UNIKA

MULTIPLE SOLUTIONS

The Foster Unika collection is a kitchen sink classic for minimal aesthetics combined with maximum practicality. Square-shaped, with a modern design and increased capacity, the bowls reach a significant depth of over 20 cm, thanks to advanced production technology that offers great capacity and convenience in all washing operations.

N265 F50
Unika 500
Brushed finish





VINTAGE FINISH

Foster Vintage is the ideal finish to give your kitchen a retro touch. Thanks to a precise brushing process using fine plant fibre brushes, Foster has created a special texture that is not afraid of scratches or nicks.

N265 F80
Unika 500
Vintage finish

R497 A20
Mixer Verona Plus
Satin finish



DETAILS AND COMBINATIONS

The vintage finish further enhances the PVD Foster colours that are applied to the Unika undermount models. The finish of the sink contrasts with the chrome finish of the drain basket and overflow cover, offering the possibility of creating a perfect match with the Verona mixers.

N157 S88
Unika 710
PVD Copper
Vintage finish

R497 D06
Mixer Verona
PVD Copper
Chrome finish

SINKS

BRUSHED PVD GUN METAL

FOSTER UNIKA

UNDERMOUNT



SINKS

N157 S56
Unika 710
PVD Gun Metal
Brushed finish

R498 S56
Mixer Verona Plus
PVD Gun Metal
Chrome finish



The accessories are also designed to match the look of the washing area and make it even more functional. Thanks to the PVD, the sink becomes an accent piece that stands out in the kitchen space, giving a touch of colour that warms up the room with class and a distinctive elegance.

S156 S59
Unika 400
S157 S59
Unika 710
PVD Gold
Fumé finish

S156 S56
Unika 400
PVD Gun Metal
Fumé finish

R498 A29
Mixer Verona Plus
PVD Gold
Brushed finish

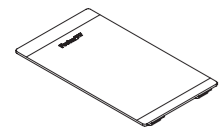

A631 C 00
glass cutting board
23,4 x 41,4 cm
€ 149

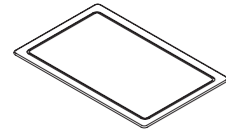

A6 57 F0 2
HDPE cutting board grey
27,2 x 42 cm
€ 169

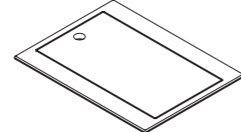

A644 A01
HDPE double cutting board
31,7 x 41,8 cm
€ 159



A644 F43
Twin Iroko cutting board
32 x 42 cm
€ 200

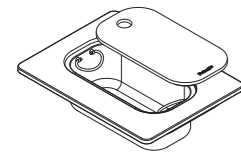

A644 F 44
Iroko cutting board kit
31,7 x 42 cm
€ 349



A154 F43 with A644 F04
perforated steel colander with handles
17 x 32 cm
€ 199

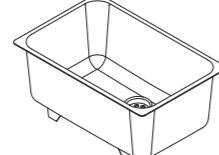

A153 A 00
white bowl
41,4 x 27,2 cm
€ 109

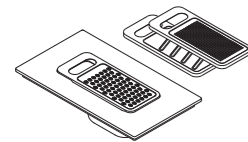

A159 A01 with A644 A01
grater kit with support ring
and bowl
€ 189

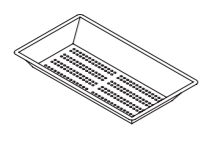

A151 F00 with A644 A01
perforated stainless steel bowl
21,5 x 38 cm
€ 319

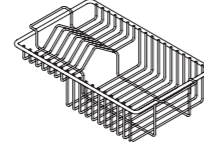

A100 B01
stainless steel plate rack
25 x 42,5 cm
€ 119

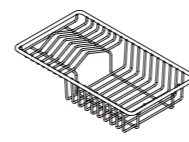

A100 C03 with A644 A01
stainless steel plate rack
21,4 x 37,9 cm
€ 119



8151 006 - with A644 A01
stainless steel perforated pan Gun Metal
21,5 x 38 cm
€ 479



8151 008 - with A644 A01
stainless steel perforated pan Copper
21,5 x 38 cm
€ 479

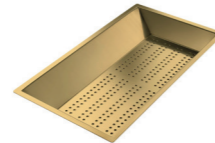

8151 009 - with A644 A01
stainless steel perforated pan Gold
21,5 x 38 cm
€ 479



UNIKA - framed
p. 90



UNIKA - double
p. 96



UNIKA - classic
p. 92



UNIKA
p. 98

UNIKA 710
 Dimensions 770 x 520 mm
 1 bowl 710 x 400 mm
 Bowl depth 195 mm
 Waste fitting 3,5" Fade | basket
 BASE 80 cm



Installation **FT | FTS**

N266 F50 € 1109
 Brushed AISI 304 st. steel

N266 F80 € 1295
 Vintage AISI 304 st. steel

UNIKA 500
 Dimensions 560 x 520 mm
 1 bowl 500 x 400 mm
 Bowl depth 195 mm
 Waste fitting 3,5" Fade | basket
 BASE 60 cm



Installation **FT | FTS**

N265 F50 € 1009
 Brushed AISI 304 st. steel

N265 F80 € 1069
 Vintage AISI 304 st. steel

UNIKA 450
 Dimensions 510 x 520 mm
 1 cuve 450 x 400 mm
 Bowl depth 195 mm
 Waste fitting 3,5" Fade | basket
 BASE 60 cm



Installation **FT | FTS**

N264 F50 € 935
 Brushed AISI 304 st. steel

N264 F80 € 1035
 Vintage AISI 304 st. steel



UNIKA 710
750 x 440 mm
1 bowl 710 x 400 mm
Bowl depth cuve 195 mm
Waste fitting 3,5" basket
BASE 80 cm



Installation FT | FTS

N157 F50 € 899
Brushed AISI 304 st. steel

N157 F80 € 1089
Vintage AISI 304 st. steel

N157 F56 € 1690
PVD Gun Metal - brushed

N157 F86 € 1890
PVD Gun Metal - vintage

UNIKA 500
540 x 440 mm
1 bowl 500 x 400 mm
Bowl depth cuve 195 mm
Waste fitting 3,5" basket
BASE 60 cm



Installation FT | FTS

N155 F50 € 739
Brushed AISI 304 st. steel

N155 F80 € 899
Vintage AISI 304 st. steel

N155 F56 € 1349
PVD Gun Metal - brushed

N155 F86 € 1479
PVD Gun Metal - vintage

UNIKA 450
490 x 440 mm
1 bowl 450 x 400 mm
Bowl depth cuve 195 mm
Waste fitting 3,5" basket
BASE 60 cm



Installation FT | FTS

N154 F50 € 699
Brushed AISI 304 st. steel

N154 F56 € 1319
PVD Gun Metal - brushed

UNIKA 400
440 x 440 mm
1 bowl 400 x 400 mm
Bowl depth cuve 195 mm
Waste fitting 3,5" basket
BASE 45 cm



Installation FT | FTS

N156 F50 € 679
Brushed AISI 304 st. steel

N156 F80 € 819
Vintage AISI 304 st. steel

N156 F56 € 1229
PVD Gun Metal - brushed

N156 F86 € 1349
PVD Gun Metal - vintage



FTS | cut-out for Flush resting on top

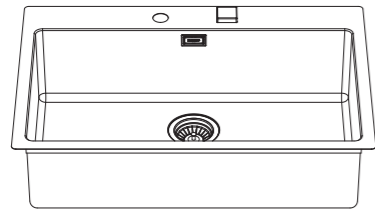

FT | cut-out for Flush-mount

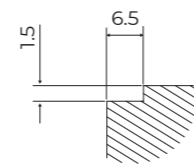
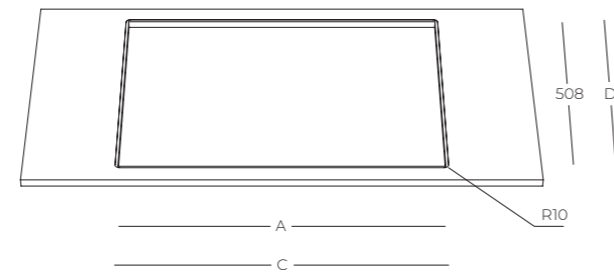
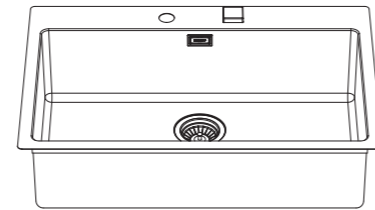

constant recess

FTS | cut-out for Flush resting on top

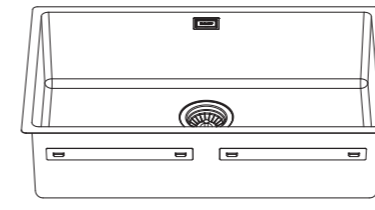

FT | cut-out for Flush-mount

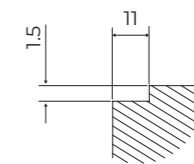
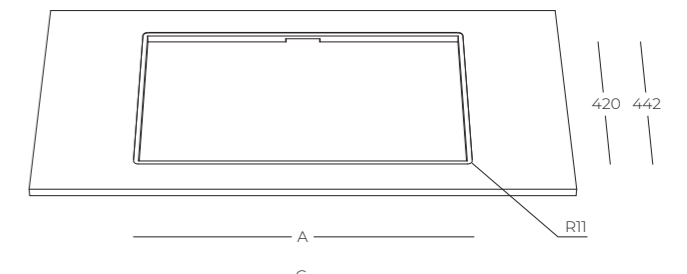
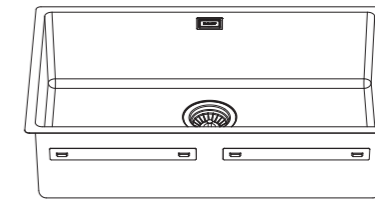

constant recess

product	FT FTS - cut-out A x 508	FT - recess C x D	
UNIKA 710	758 x 508 mm	771 x 521 mm	R10.5
UNIKA 500	548 x 508 mm	561 x 521 mm	R10.5
UNIKA 450	498 x 508 mm	511 x 521 mm	R10.5

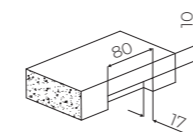

product	FT FTS - cut-out A x 420	FT - recess C x 442	
UNIKA 710	730 x 420 mm	752 x 442 mm	R11
UNIKA 500	520 x 420 mm	542 x 442 mm	R11
UNIKA 450	470 x 420 mm	492 x 442 mm	R11
UNIKA 400	420 x 420 mm	442 x 442 mm	R11

UNIKA 750 DOUBLE

Dimensions 800 x 450 mm
2 bowls 27x40 | 45x40 cm
Bowl depth 195 mm
Waste fitting 3,5" basket
BASE 90 cm



Installation **UM**

N205 S50 € 979
Brushed AISI 304 st. steel

UNIKA 710 DOUBLE

Dimensions 760 x 450 mm
2 bowls 18x40 | 50x40 cm
Bowl depth 140 | 195 mm
Waste fitting 3,5" basket
BASE 90 cm



Installation **UM**

N204 S51 right € 949
Brushed AISI 304 st. steel

N204 S52 left € 949
Brushed AISI 304 st. steel

UNIKA 710 DOUBLE

Dimensions 760 x 450 mm
2 bowls 34x40 | 34x40 cm
Bowl depth 195 mm
Waste fitting 3,5" basket
BASE 80 cm



Installation **UM**

N203 S50 € 919
Brushed AISI 304 st. steel

UNIKA 610 DOUBLE

Dimensions 660 x 450 mm
2 bowls 18x40 | 40x40 cm
Bowl depth 140 | 195 mm
Waste fitting 3,5" basket
BASE 80 cm



Installation **UM**

N202 S51 right € 879
Brushed AISI 304 st. steel

N202 S52 left € 879
Brushed AISI 304 st. steel

UNIKA 545 DOUBLE

Dimensions 585 x 440 mm
2 bowls 18x40 | 34x40 cm
Bowl depth 140 | 195 mm
Waste fitting 3,5" basket
BASE 60 cm



Installation **UM**

N201 S51 right € 849
Brushed AISI 304 st. steel

N201 S52 left € 849
Brushed AISI 304 st. steel





UNIKA 710
 Dimensions 750 x 440 mm
 1 bowl 710 x 400 mm
 Bowl depth 195 mm
 Waste fitting 3,5" basket
 BASE 80 cm

Installation **UM**



N157 S50 € 849
 Brushed AISI 304 st. steel

N157 S80 € 1039
 Vintage AISI 304 st. steel

UNIKA 500
 Dimensions 540 x 440 mm
 1 bowl 500 x 400 mm
 Bowl depth 195 mm
 Waste fitting 3,5" basket
 BASE 60 cm

Installation **UM**



N155 S50 € 699
 Brushed AISI 304 st. steel

N155 S80 € 839
 Vintage AISI 304 st. steel

UNIKA 450
 Dimensions 490 x 440 mm
 1 bowl 450 x 400 mm
 Bowl depth 195 mm
 Waste fitting 3,5" basket
 BASE 60 cm

Installation **UM**



N154 S50 € 679
 Brushed AISI 304 st. steel

UNIKA 400
 Dimensions 440 x 440 mm
 1 bowl 400 x 400 mm
 Bowl depth 195 mm
 Waste fitting 3,5" basket
 BASE 60 cm

Installation **UM**



N156 S50 € 659
 Brushed AISI 304 st. steel

N156 S80 € 789
 Vintage AISI 304 st. steel

UNIKA 340
 Dimensions 380 x 440 mm
 1 bowl 340 x 400 mm
 Bowl depth 195 mm
 Waste fitting 3,5" basket
 BASE 45 cm

Installation **UM**



N153 S50 € 639
 Brushed AISI 304 st. steel

UNIKA 270
 Dimensions 310 x 440 mm
 1 bowl 270 x 400 mm
 Bowl depth 195 mm
 Waste fitting 3,5" basket
 BASE 40 cm

Installation **UM**



N152 S50 € 599
 Brushed AISI 304 st. steel

UNIKA 710
750 x 440 mm
1 bowl 710 x 400 mm
Bowl depth 195 mm
Waste fitting 3,5" basket
BASE 80 cm



Installation **UM**

N157 S56 € 1590
PVD Gun Metal - brushed

N157 S86 € 1789
PVD Gun Metal - vintage

S157 S56 € 1789
PVD Gun Metal - fumé

N157 S58 € 1590
PVD Copper - brushed

N157 S88 € 1789
PVD Copper - vintage

S157 S58 € 1789
PVD Copper - fumé

N157 S59 € 1590
PVD Gold - brushed

N157 S89 € 1789
PVD Gold - vintage

S157 S59 € 1789
PVD Gold - fumé

UNIKA 500
540 x 440 mm
1 bowl 500 x 400 mm
Bowl depth 195 mm
Waste fitting 3,5" basket
BASE 60 cm



Installation **UM**

N155 S56 € 1249
PVD Gun Metal - brushed

N155 S86 € 1349
PVD Gun Metal - vintage

S155 S56 € 1349
PVD Gun Metal - fumé

N155 S58 € 1249
PVD Copper - brushed

N155 S88 € 1349
PVD Copper - vintage

S155 S58 € 1349
PVD Copper - fumé

N155 S59 € 1249
PVD Gold - brushed

N155 S89 € 1349
PVD Gold - vintage

S155 S59 € 1349
PVD Gold - fumé

UNIKA 450
490 x 440 mm
1 bowl 450 x 400 mm
Bowl depth 195 mm
Waste fitting 3,5" basket
BASE 60 cm



Installation **UM**

N154 S56 € 1219
PVD Gun Metal - brushed

UNIKA 400
440 x 440 mm
1 bowl 400 x 400 mm
Bowl depth 195 mm
Waste fitting 3,5" basket
BASE 60 cm



Installation **UM**

N156 S56 € 1099
PVD Gun Metal - brushed

N156 S86 € 1199
PVD Gun Metal - vintage

S156 S56 € 1199
PVD Gun Metal - fumé

N156 S58 € 1099
PVD Copper - brushed

N156 S88 € 1199
PVD Copper - vintage

S156 S58 € 1199
PVD Copper - fumé

N156 S59 € 1099
PVD Gold - brushed

N156 S89 € 1199
PVD Gold - vintage

S156 S59 € 1199
PVD Gold - fumé

UNIKA 340
380 x 440 mm
1 bowl 340 x 400 mm
Bowl depth 195 mm
Waste fitting 3,5" basket
BASE 45 cm



Installation **UM**

N153 S56 € 1049
PVD Gun Metal - brushed

UM | cut-out for Undermount

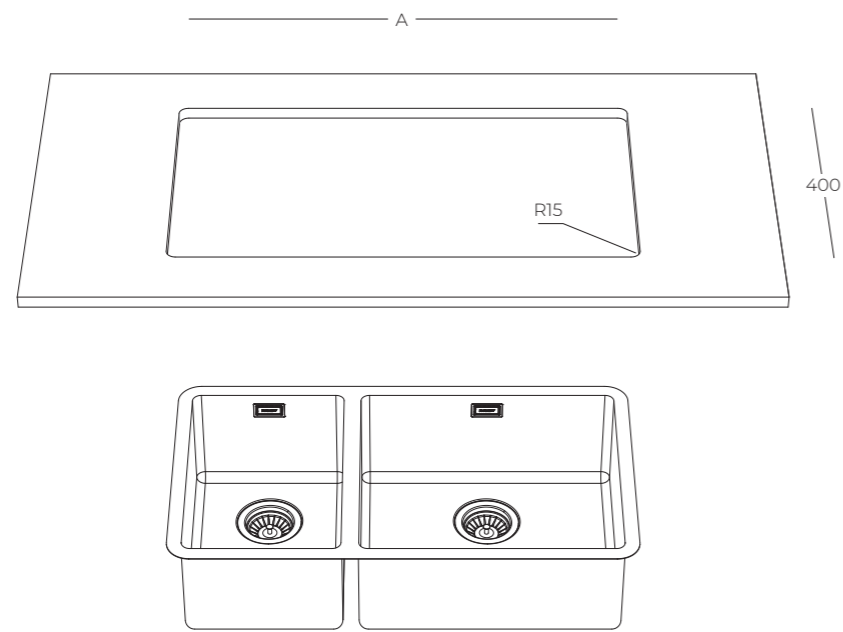

product	UM - cut-out A x 400	
UNIKA DOUBLE 750	750 x 400 mm	R15
UNIKA DOUBLE 710	710 x 400 mm	R15
UNIKA DOUBLE 610	610 x 400 mm	R15
UNIKA DOUBLE 545	545 x 400 mm	R15

UM | cut-out for Undermount

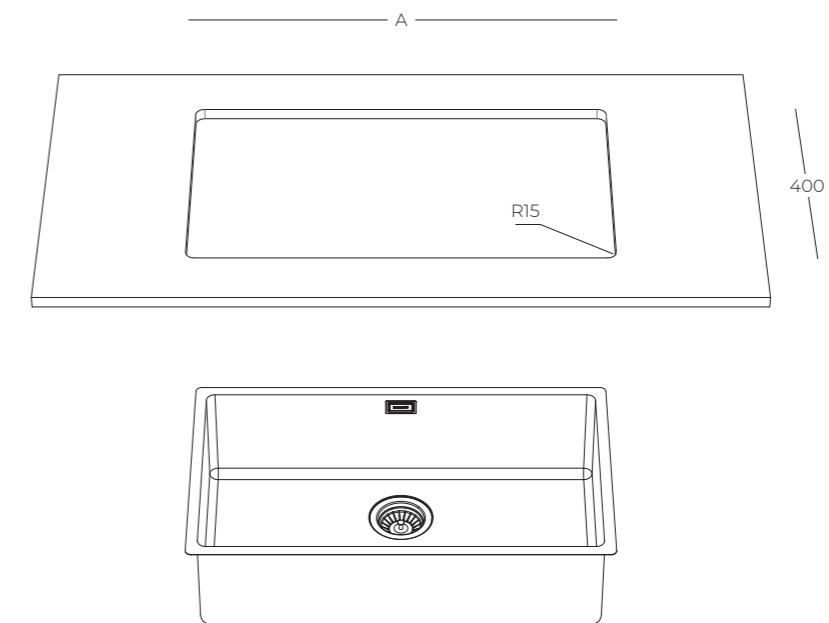

product	UM - cut-out A x 400	
UNIKA 710	710 x 400 mm	R15
UNIKA 500	500 x 400 mm	R15
UNIKA 450	450 x 400 mm	R15
UNIKA 400	400 x 400 mm	R15
UNIKA 340	340 x 400 mm	R15
UNIKA 270	270 x 400 mm	R15