

GEMMA
 Installation FT | TM
 Product versions x2
 Brushed finish
 PVD
 p. 136



SPOT
 Installation FT | FTS
 Product versions x2
 Ceramic glass
 Black | White finish
 p. 150



KOLORE
 Installation FT | FTS
 Ceramic glass
 p. 160

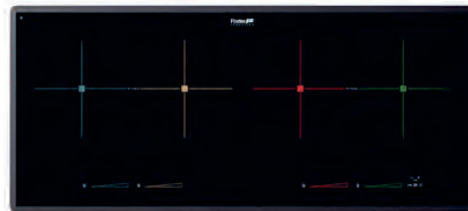

SPACE
 Installation FT | FTS
 Ceramic glass
 p. 164



PUNTO
 Installation FT | FTS
 Product versions x5
 Ceramic glass
 p. 170



VENTO
 Installation FT | FTS
 Ceramic glass
 p. 180



TRIO
 Installation FT | FTS
 Ceramic glass
 p. 188



MILANO
 Installation FT | FTS
 Product versions x2
 Brushed finish
 PVD
 p. 190

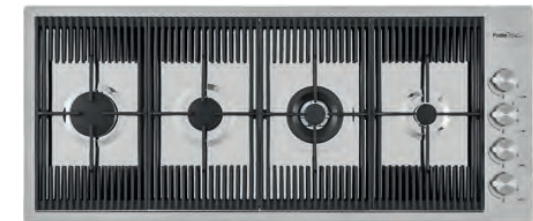

COSMO
 Installation FT | FTS
 Brushed finish
 PVD
 p. 202



OPERA
 Installation FT | FTS
 Product versions x2
 Brushed finish
 PVD
 p. 212



**GO&STOP DEVICE**

Activates the plates initially at maximum power, until the set level is reached

**RECALL**

The function allows immediate recall of the last settings selected in the previous cooking process

**POWER BOOST**

When the Booster is activated, the plate runs for ten minutes at a very high power level, which makes it possible to, for example, quickly heat up large quantities of water

**DOUBLE POWER BOOST**

Two additional power boost settings up to 3700 W, usable on a single zone or spread over the entire extended bridge zone (if present)

**POT LOCALIZATION**

It recognises which zone the pan is placed on and automatically activates the relevant controls to adjust the power

**SMART FAN SYSTEM**

The Foster system automatically adjusts the optimal ventilation level according to the temperatures reached

**END-OF-COOKING PROGRAM**

All operations are set via touch controls on the cooktop glass. Each hotplate is equipped with independent programming that allows you to set different cooking times

**T-CHEF**

It allows to set particular temperatures (42 °C, 70 °C, 94 °C) and keep them constant during cooking. This makes it easy to achieve elaborate preparations with true chef's results. Bain-marie preparations, custard or béchamel will always be perfect, as will slow cooking at low temperatures. By setting the temperature close to boiling, the cooking liquids will immediately come up to temperature when needed, increasing speed and performance

**HEAT MAINTENANCE**

It allows to keep food at a temperature of 70°C in a gentle way, without reaching boiling temperatures or burning the cooking juices

**TIMER**

A convenient timer that is independent of end-of-cooking programming

**SLIDER CONTROL**

The selected temperature can be set very quickly with the Slider control: simply touch the touch display to the desired power level with one finger

**POT DETECTOR**

Foster cooktop not only recognise the presence of pots and pans, but also calculate their surface area. This system allows an even more efficient use of energy. Moreover, when the pan is removed, the plate is automatically deactivated

**BRIDGE**

The Bridge function allows two zones to be combined to form a single large cooking zone, available for large pots or for multiple simultaneous cooking, with maximum flexibility in positioning. Thanks to the Double Booster, the exceptional power of 3700 W can be concentrated on a single plate or made available evenly over the extended surface area

**SAFETY**

All Foster electric hobs are equipped with the most modern and sophisticated safety protections: centralized stop, safety lock, residual heat indicators. The induction models also have the following functions: Safety system, which turns off the hob if no pans are present; Overflow detector, which automatically turns off the hob if liquid overflows; Automatic deactivation, to avoid accidents due to forgetfulness.

**POWER CONTROL**

The PowerControl function allows free use of induction technology, even with standard 3 kW appliances. In fact, the user can easily change the maximum absorption level of the hob, from a minimum of 2.8 kW to the "no restriction" solution. Once the maximum power is set, we can forget about the absorption, as the Foster induction hob will warn us of any limit, leaving us the choice to distribute the power as we wish. At any time, the hob can be easily reprogrammed to change or remove the power limit.

GEMMA

CERAMIC GLASS AND STEEL

Steel sculpted to fit induction technology. The combination of materials of the bevelled glass-ceramic modules and the steel in PVD colours for a valuable and versatile cooking area.



INDUCTION COOKTOPS



THE CORNER COOKTOP

The angular design creates elegant cooking zones that optimise space without sacrificing comfort. Thanks to the slight elevation of the cooking modules in relation to the steel top, pans can slide from one position to another without losing contact with the glass-ceramic surface.

I438 N00
Gemma corner

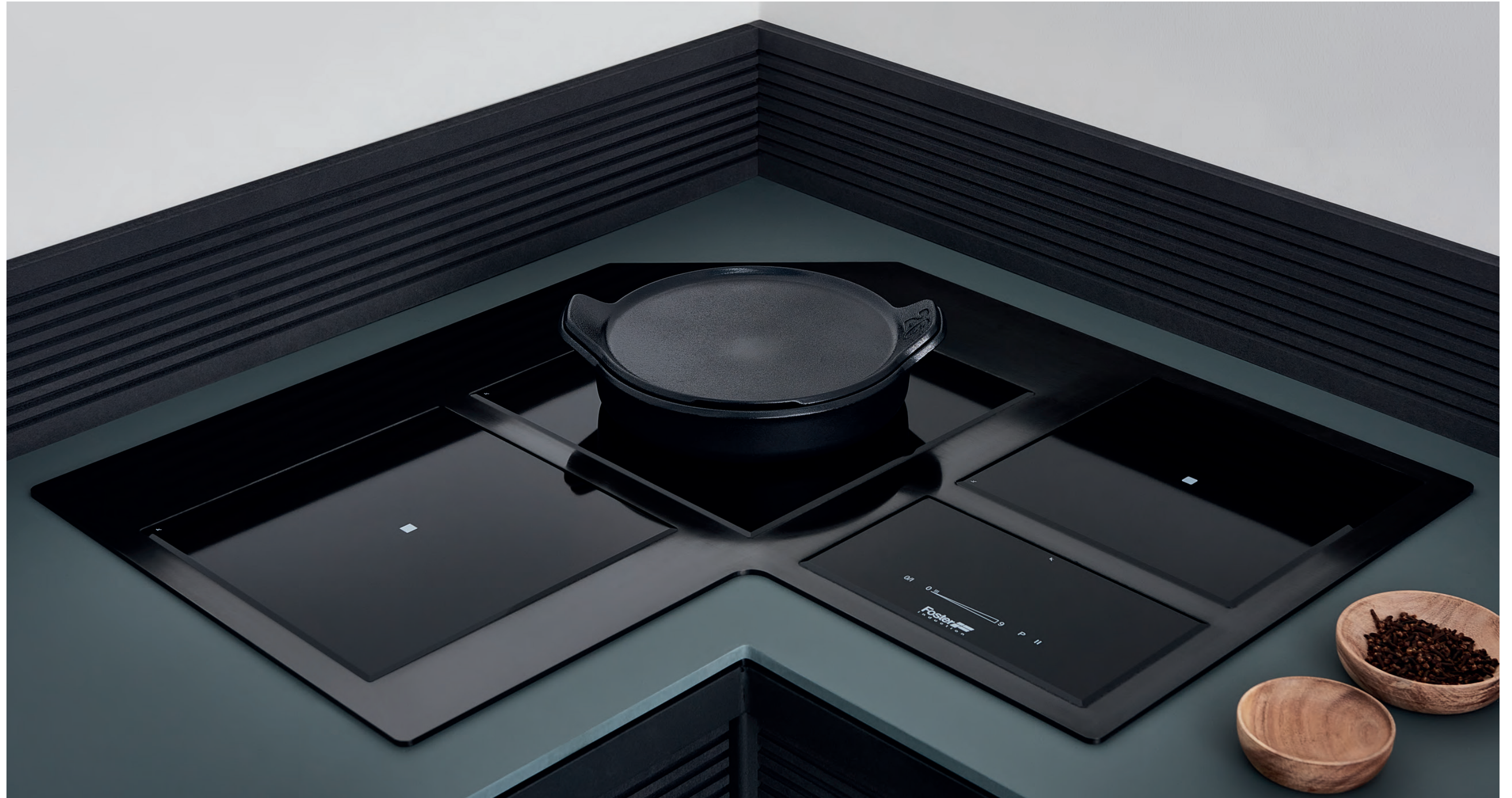

I438 N06
Gemma corner
PVD Gun Metal



I439 N00
Gemma line

GEMMA CORNER
 Dimensions 830 x 830 x h 4 mm
 1 independent control area
 1 cooking zone 270 mm
 1 cooking zone 300 mm
 1 cooking zone 350 mm
 Total power 6.700 W

BASE 90 corner

Installation FT | TM



I438 N00 € 3999
 Brushed INOX AISI 304 st. steel



I438 N06 € 5199
 Brushed INOX AISI 304 st. steel PVD Gun Metal



I438 N08 € 5199
 Brushed INOX AISI 304 st. steel PVD Copper



I438 N09 € 5199
 Brushed INOX AISI 304 st. steel PVD Gold

GEMMA LINE
 Dimensions 1080 x 490 x h 4 mm
 1 independent control area
 1 cooking zone 270 mm
 2 cooking zones 350 mm
 Total power 6.700 W

BASE 120

Installation FT | TM



I439 N00 € 3599
 Brushed INOX AISI 304 st. steel



I439 N16 € 4499
 Brushed INOX AISI 304 st. steel PVD Gun Metal



I439 N18 € 4499
 Brushed INOX AISI 304 st. steel PVD Copper



I439 N19 € 4499
 Brushed INOX AISI 304 st. steel PVD Gold



-  Powerboost
-  Recall
-  Pot detector
-  Timer
-  Security
-  Slider control
-  Go&Stop
-  Heat maintenance
-  Smart fan system
-  End-of-cooking program
-  Pause

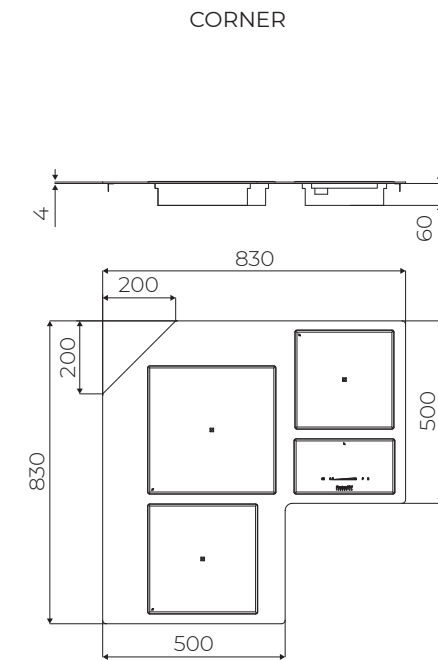

Maximum dimensions 830 x 830 mm
 1 control zone
 1 induction zone 270 mm - 1,100 (1,400)* W
 1 induction zone 300 mm - 2,300 (3,000)* W
 1 induction zone 350 mm - 2,300 (3,000)* W
 Total power 6,700 W

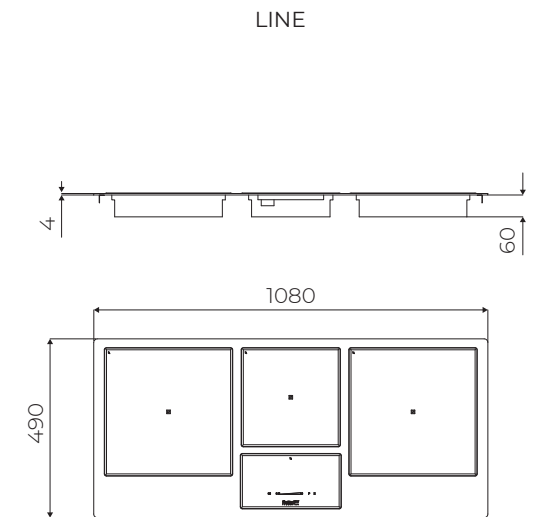

Maximum dimensions 1080 x 490 mm
 1 control zone
 1 induction zone 270 mm - 1,100 (1,400)* W
 2 induction zones 350 mm - 2,300 (3,000)* W
 Total power 6,700 W

GEMMA
 induction cooking system

Corner worktop in 4 mm thick AISI 304 stainless steel in satin finish with three glass ceramic induction zones with integrated bevelled edge with FT installation flush with the steel body.

1 electronic programming panel for the independent cooking zones with touch technology and cursor control
 9 power settings per zone plus *Powerboost function
 Power supply 230 - 380 V (50/60 Hz)

INCLUDED
 Connection box
 Dimensions 211 x 270 x 48 mm
 Wall installation behind the base unit
 or inside, under the hob

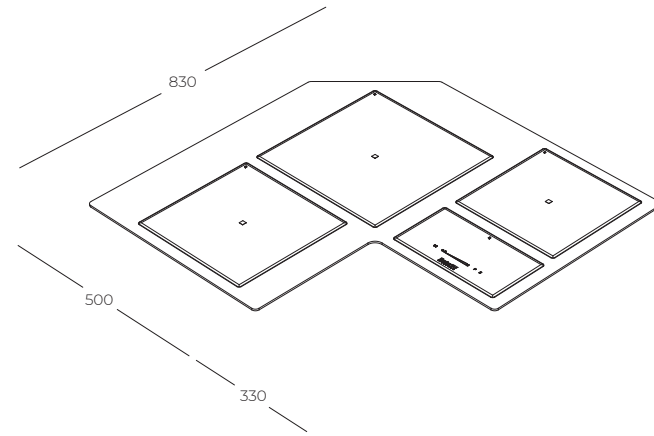

TM | cut-out for Top mount

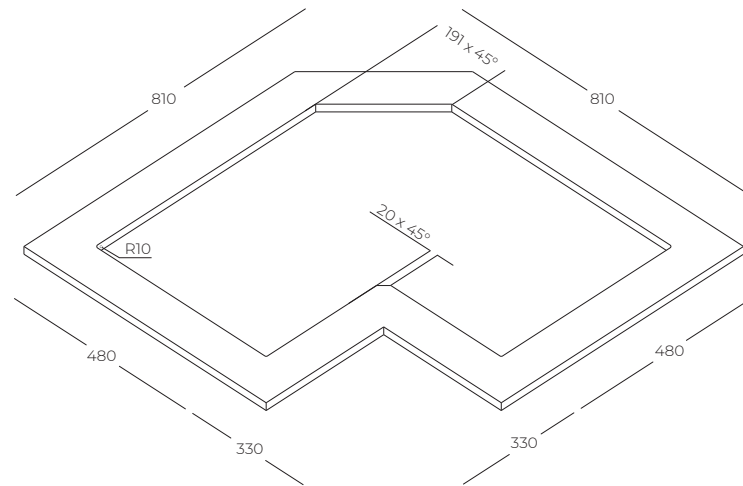

FT | cut-out for Flush-mount

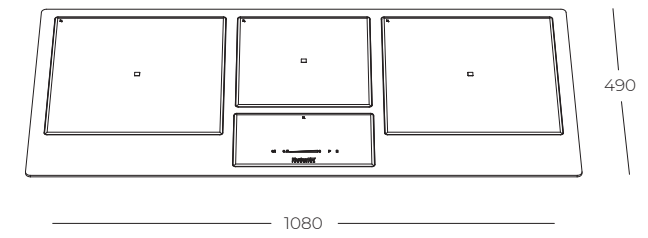
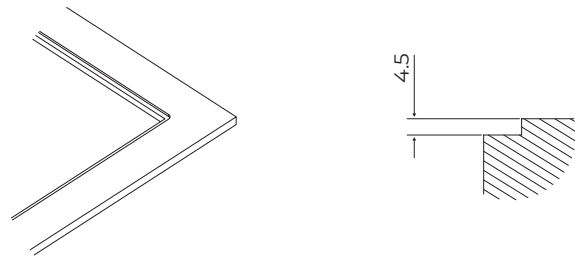

TM | cut-out for Top mount

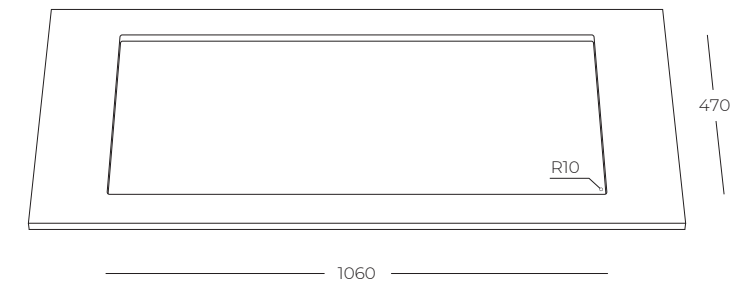

FT | cut-out for Flush-mount

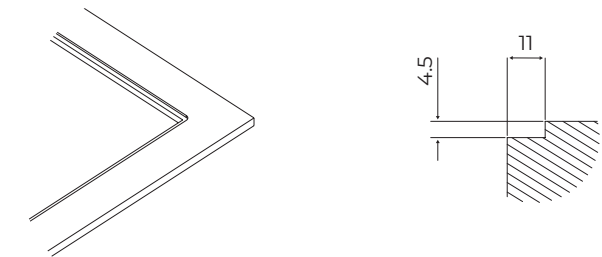

SPOT

THE TAILORED HOB

Maximum freedom to compose your induction hob according to your kitchen space and specific needs. The three hob models, which differ in diameter and power, can be positioned with great flexibility in combinations of two, three or four zones controlled directly by a single control panel.

I365 N40
Spot squared 4 zones





The cooking zone modules are made of glass ceramic and are available in square and round shapes. The square shape is only available in black and is characterised by a bevelled edge and a small central silk-screen print on the individual cooking modules. The square shape is available in two versions, one in white and one in black and is characterised by a 4 mm high sharp edge.

I366 N30
Spot round 3 zones black

4 PLATES squared

- 1 Touch control
- 1 connection box
- 1 zone 300 mm
- 1 zone 350 mm
- 2 zones 270 mm



Installation **FTS | FT**

I365 N40 € 2999
Black

3 PLATES squared

- 1 Touch control
- 1 connection box
- 1 zone 350 mm
- 1 zone 300 mm
- 1 zone 270 mm

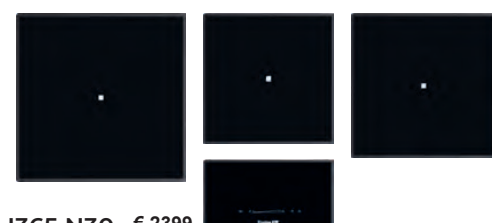

Installation **FTS | FT**

I365 N30 € 2399
Black

2 PLATES squared

- 1 Touch control
- 1 connection box
- 1 zone 350 mm
- 1 zone 270 mm

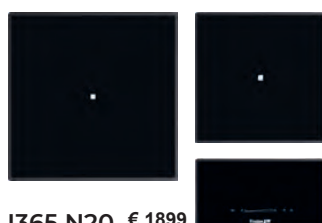

Installation **FTS | FT**

I365 N20 € 1899
Black

4 PLATES round

- 1 Touch control
- 1 connection box
- 2 zones ø300
- 2 zones ø270

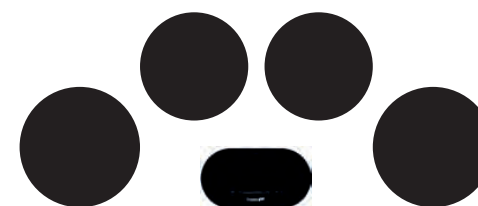

Installation **FTS | FT**

I366 N40 € 2659
Black

3 PLATES round

- 1 Touch control
- 1 connection box
- 1 zone ø350
- 1 zone ø300
- 1 zone ø270

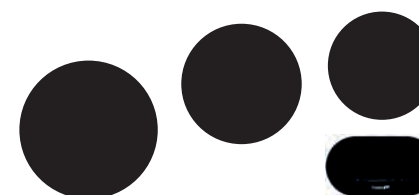

Installation **FTS | FT**

I366 N30 € 2359
Black

2 PLATES round

- 1 Touch control
- 1 connection box
- 1 zone ø350
- 1 zone ø270



Installation **FTS | FT**

I366 N00 € 1859
Black



I366 B45 € 2899
White

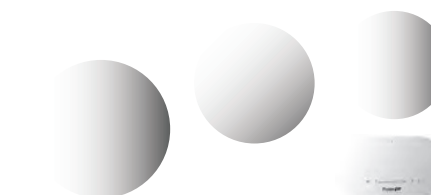

I366 B35 € 2499
White



I366 B05 € 1999
White



-  Powerboost
-  Recall
-  Pot detector
-  Timer
-  Security
-  Slider control
-  Go&Stop
-  Heat maintenance
-  Smart fan system
-  End-of-cooking program
-  Pause

Connexion box
 Power supply 230 - 380 V (50/60 Hz)
 Recommended installation:
 wall mounting behind the base unit or
 inside the base unit, under the table.

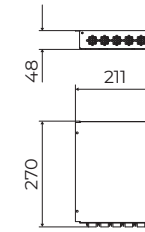

SQUARED CONTROL ZONE

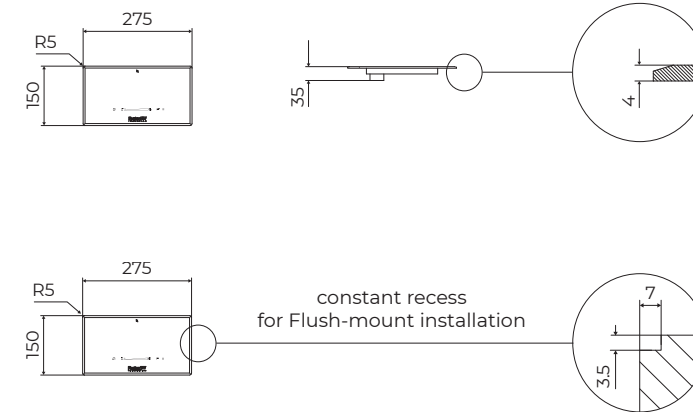

SQUARED INDUCTION ZONES

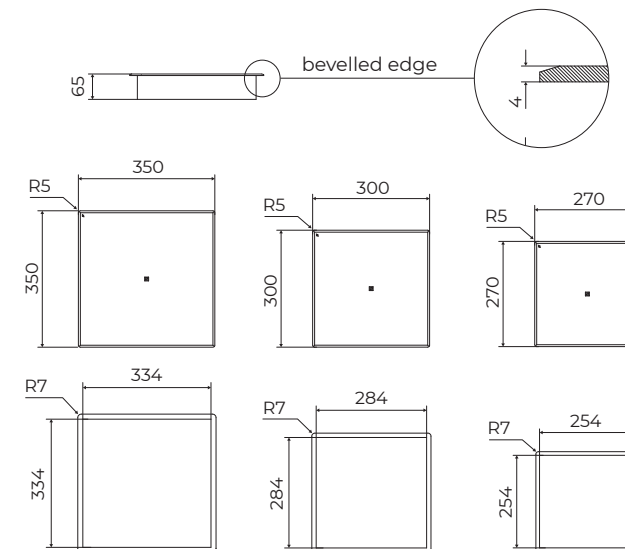

constant recess
 for Flush-mount installation

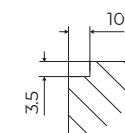



-  Powerboost
-  Recall
-  Pot detector
-  Timer
-  Security
-  Slider control
-  Go&Stop
-  Heat maintenance
-  Smart fan system
-  End-of-cooking program
-  Pause

Connexion box
 Power supply 230 - 380 V (50/60 Hz)
 Recommended installation:
 wall mounting behind the base unit or
 inside the base unit, under the table.

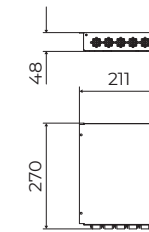

ROUND CONTROL ZONE

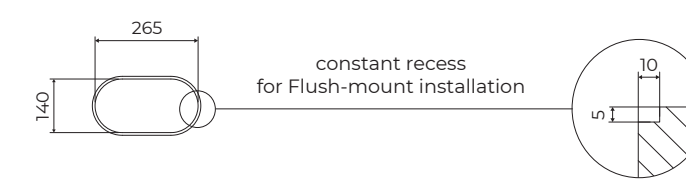
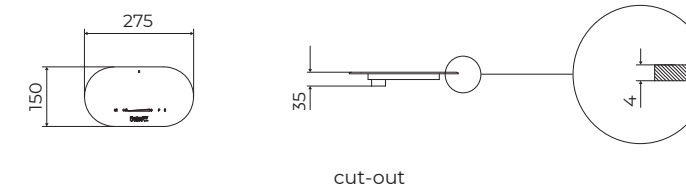

ROUND INDUCTION ZONES

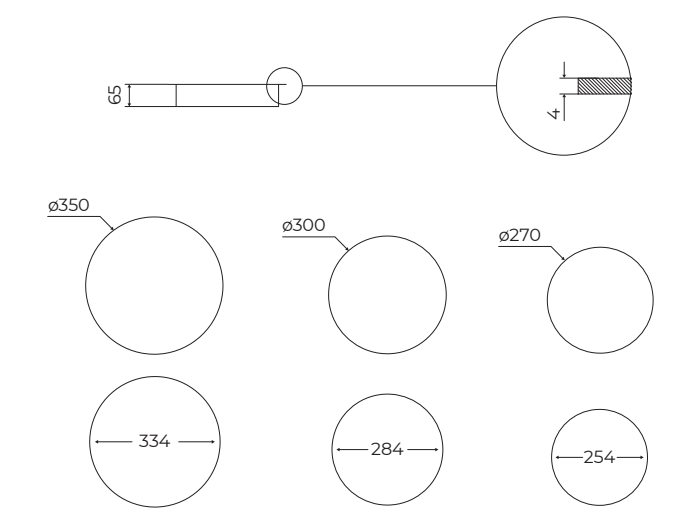

constant recess
for Flush-mount installation

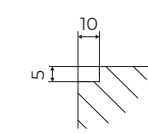

KOLORE



ATTRACTIVE DESIGN

An attractive design, the result of careful user research. The colours not only identify the cooking zones, but also strongly characterise the distinctive design of this hob. Each element can be controlled by its own slider control which allows the cooking intensity to be adjusted by touching the display.

I334 N45
Kolore 4 zones



FUNCTIONS

-  Powerboost
-  Recall
-  Pot detector
-  Timer
-  Security
-  Slider control
-  Go&Stop
-  T-chef
-  Smart fan system
-  Bridge
-  End-of-cooking program
-  Pause

FOSTER KOLORE

FEATURES

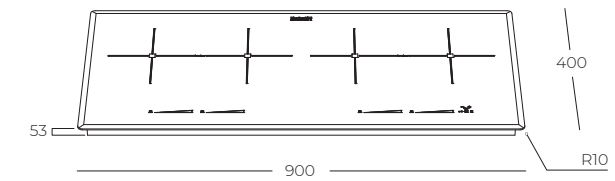

TM | cut-out for Top-mount

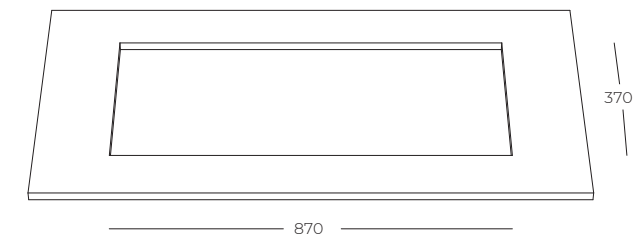

FT | cut-out for Flush-mount

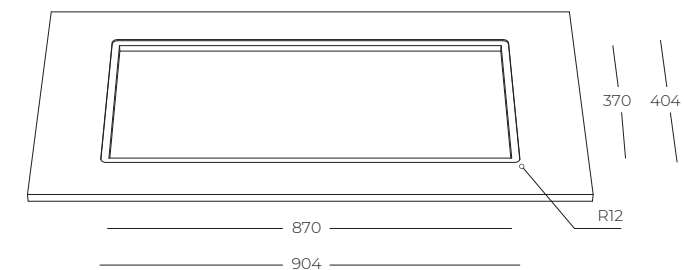
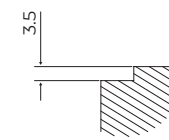

KOLORE
I334 N45
cooking system

€ 2299

4 mm thick black glass-ceramic induction plate with bevelled edge. In-line cooking zones with 4-colour silk-screen printing. Top or flush installation.

Electronic programming of the cooking zones with Touch technology and Slider control
9 power settings per zone plus Powerboost function
4 cooking zones 180 x 220 mm - 2,100 (3,700)* W
2 combinable zones with bridge function
Recommended installation base 120 cm

Maximum footprint 900 x 400 x h50 mm
Single-phase power supply 230 V - 1P+N
Two-phase power supply 400 V - 2P+N
Frequency 50/60 Hz

*Powerboost

SPACE

UNLIMITED COOKING SPACE

Space is the first Foster hob in which the cooking area knows no boundaries. Made of glass-ceramic with bevelled edges, its essential lines, thanks to the appliance's recessed design, are in line with those of the appliance itself. Built into the worktop, its essential lines blends into the kitchen surface.

I300 N00
Space induction





The fixed cooking zones disappear and each pan can be positioned and moved anywhere on the hob, even during cooking, thanks to the tracking system that can recognise the movement of up to 6 pans and follow them while maintaining the cooking power.



- P Powerboost
- +KW- Power control
- 🍲 Pot detector
- 🕒 Timer
- 🔒 Security
- 📊 Slider Control
- 🎯 Pot dedector
- 👨‍🍳 T-chef
- 🕒 End-of-cooking program
- ⏸ Pause

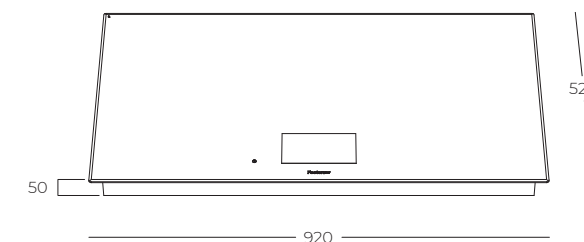

TM | cut-out for Top mount



FT | cut-out for Flush-mount

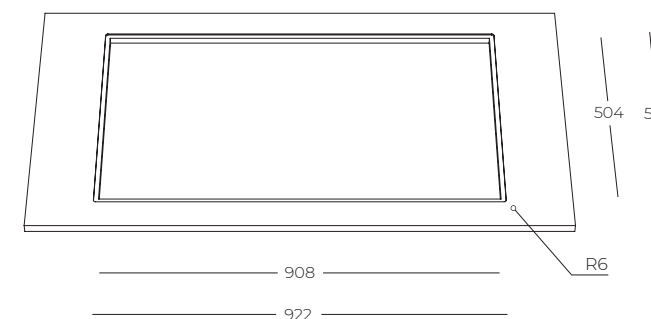
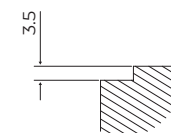

SPACE € 4999
I300 N00
 free zone cooking system

Black glass ceramic induction hob with bevelled edge equipped with 7" TFT touch screen and slide control for electronic programming of cooking zones
 8 languages available (IT, EN, DE, FR, ES, CN, KO, VIET)

Product dimensions 520 x 920 x h 50 mm
 Recommended installation base 120 cm
 Power supply 230 - 380 V (50/60 Hz)

Free cooking zones - up to 6 pans
 17 power settings per zone plus Powerboost and T-chef (+ 3 temperatures) for a total of 21 levels per zone
 Total power 11,000 W
 Power limit function

PUNTO

A WIDE RANGE OF SOLUTIONS

Simple and essential, this is the glass of the Punto collection hobs. Available in a range of sizes, the range also includes dual-zone solutions with the Bridge function, which allows two zones to be combined to form one large cooking zone, to fit into smaller spaces without sacrificing efficiency. These hobs are highly efficient, equipped with a Powerboost function and a heat retention system for preparations requiring better temperature control.

I380 N45
Punto 290 induction



SPACE

UNLIMITED COOKING SPACE

Space is the first Foster hob in which the cooking area knows no boundaries. Made of glass-ceramic with bevelled edges, its essential lines, thanks to the appliance's recessed design, are in line with those of the appliance itself. Built into the worktop, its essential lines blends into the kitchen surface.

I300 N00
Space induction





THE ELEGANCE OF THE DETAILS

Our induction hobs are made of glass-ceramic with a bevelled edge that allows two different types of installation, flush or above, depending on the desired effect. All operations are regulated by touch controls on the hob glass. The selected temperature can be set very quickly thanks to the Slider control: just touch the screen with a finger to reach the desired power level.

PUNTO 860
 Dimensions 860 x 510 x h 50 mm
 6 cooking zones with Slider Control
 4 cooking zones 2.100 (3.000*) W
 1 central cooking zone 2.300 (3.000*) W
 Total power 10.400* W
 BASE 90

Installation **TM | FT**



I384 N45 € 1999
 Bevelled ceramic glass - Black

PUNTO 770
 Dimensions 770 x 510 x h 50 mm
 6 cooking zones with Slider Control
 6 cooking zones 2.100 (3.000*) W
 Total power 11.100* W
 BASE 80

Installation **TM | FT**



I383 N45 € 1899
 Bevelled ceramic glass - Black

PUNTO 770
 Dimensions 770 x 510 x h 50 mm
 4 cooking zones with Slider Control
 2 cooking zones 2.100 (3.000*) W
 1 central cooking zones 2.300 (3.000*) W
 1 central cooking zones 1.400 (1.8500*) W
 Total power 7.400* W
 BASE 80

Installation **TM | FT**



I382 N45 € 1649
 Bevelled ceramic glass - Black

PUNTO 580
 Dimensions 580 x 510 x h 50 mm
 4 cooking zones with Slider Control
 2 cooking zones 2.100 (3.000*) W
 1 central cooking zones 2.300 (3.000*) W
 1 central cooking zones 1.400 (1.8500*) W
 Total power 7.400* W
 BASE 60

Installation **TM | FT**



I381 N45 € 1499
 Bevelled ceramic glass - Black

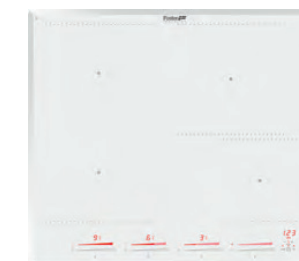

I381 B45 € 1499
 Bevelled ceramic glass - White















PUNTO 290
 Dimensions 290 x 510 x h 50 mm
 2 cooking zones with Slider Control
 2 cooking zones 2.100 (3.000*) W
 Total power 3.700* W
 BASE 45

Installation **TM | FT**



I380 N45 € 999
 Bevelled ceramic glass - Black



- | | |
|--------------------------------------------------------------------------------------------------|------------------------------------------------------------------------------------------------------------|
|  Powerboost |  Bridge |
|  Recall |  Power control |
|  Pot detector |  Pot detector |
|  Timer |  Pause |
|  Security |  Smart fan system |
|  Slider Control |  End-of-cooking program |
|  Go&Stop |  Heat maintenance |

PUNTO
cooking system

4 mm thick black glass-ceramic induction plate with bevelled edge. Cooking zones with screen printing and white LEDs. Installation on top or flush with the top.

Electronic programming of the cooking zones with Touch technology and Slider control
9 power settings per zone plus Powerboost function
All models are equipped with bridge function and power limitation.

Single-phase power supply 230 V - 1P+N
Two-phase power supply 400 V - 2P+N
Frequency 50/60 Hz

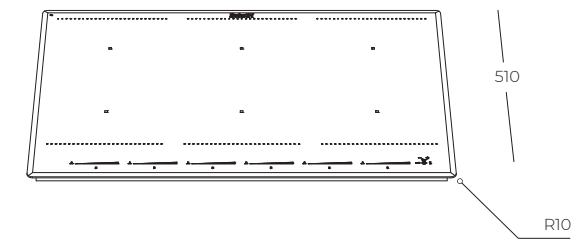

TM | cut-out for Top mount

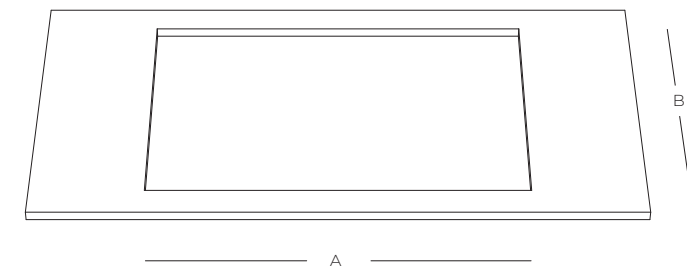

FT | cut-out for Flush-mount

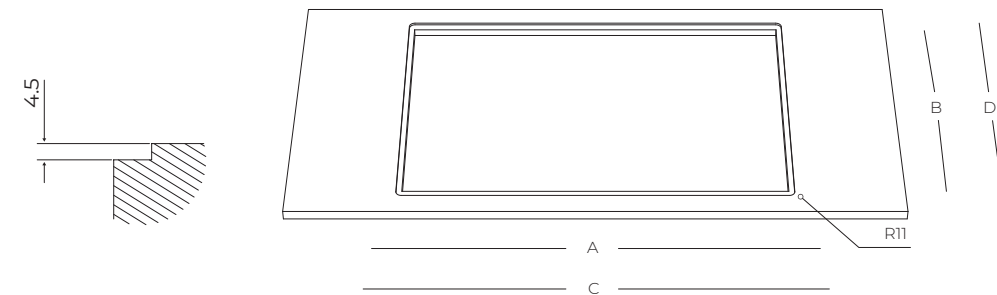

product	TM FT - cut-out A x B	FT - recess C x D	
PUNTO 860	840 x 480 mm	862 x 512 mm	R11
PUNTO 770 (x2 models)	750 x 480 mm	772 x 512 mm	R11
PUNTO 580 (x2 models)	560 x 480 mm	582 x 512 mm	R11
PUNTO 290	270 x 480 mm	292 x 512 mm	R11

VENTO





Inlet grids protect the filter area. A functional element that is also a distinctive feature of the Vento worktop. An accessory made entirely of AISI 304 stainless steel and available in a variety of PVD finishes to blend in with the kitchen.

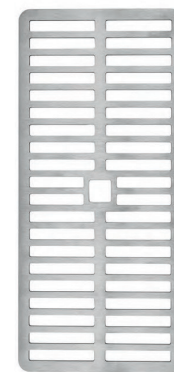

A803 F00 € 115
AISI 304 st. steel brushed

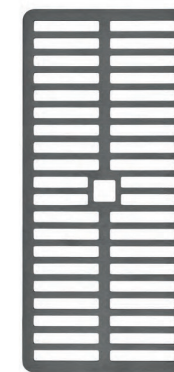

A803 A16 € 179
AISI 304 st. steel brushed PVD
Gun Metal

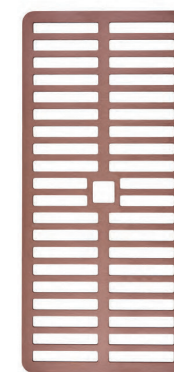

A803 A18 € 179
AISI 304 st. steel brushed
PVD Copper

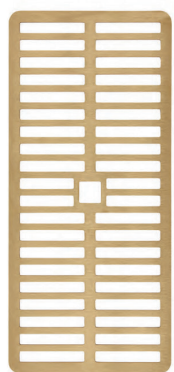

A803 A19 € 179
AISI 304 st. steel brushed
PVD Gold



Powerboost



Power control



Bridge



Timer



Security



Pot detector



Smart fan system

End-of-cooking
program

Heat maintenance



Slider control



Pause

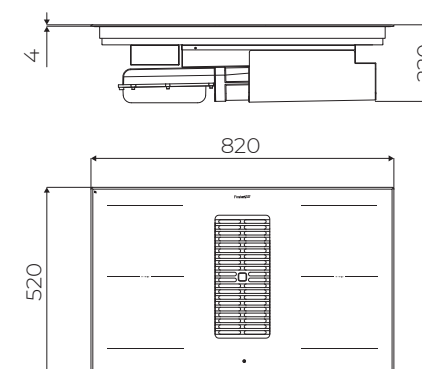

VENTO
I392 N45
cooking system with integrated extraction

€ 3999

Induction hob in black ceramic glass with bevelled edge
Integrated extractor hood with washable filters and black
cover grille

Product dimensions 520 x 820 x h 220 mm
Recommended installation base 80 cm
Energy class A+
Capacity 680 m³/h
Power supply 230 - 380 V (50/60 Hz)

SUCTION SYSTEM

Engine on board
Electronic programming
10 suction speeds (9 + 1 intensive)
Noise level 49 - 70 dB(A)
Pressure 610 Pa
Delayed automatic stop
Black aluminium grid included
2 washable grease filters included
Grease and carbon filter saturation
warnings

Control panel with Touch and Slider Control technology
9 power settings per zone plus Powerboost function
4 cooking zones 210 x 190 mm - 2,100 (3,000)* W
2 extended bridge zones
Total power 7,400 W
Power limit function

*Powerboost

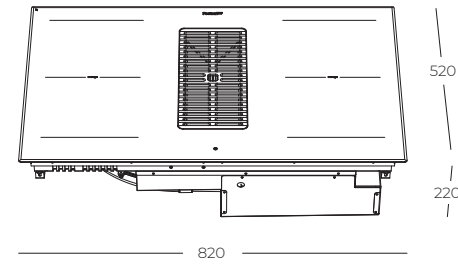

TM | cut-out for Top mount



FT | cut-out for Flush-mount

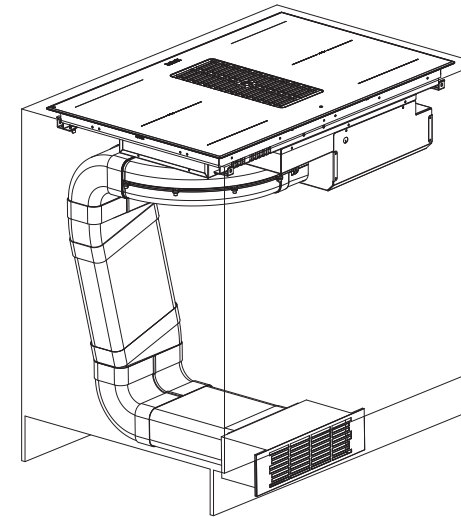
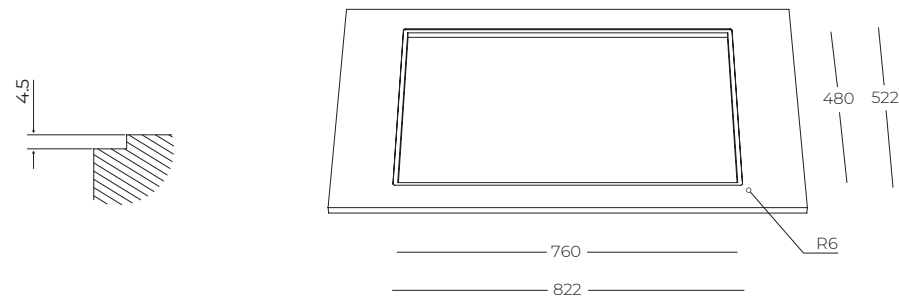

A700 D80 - Filter kit for pedestal H10/15 cm € 950

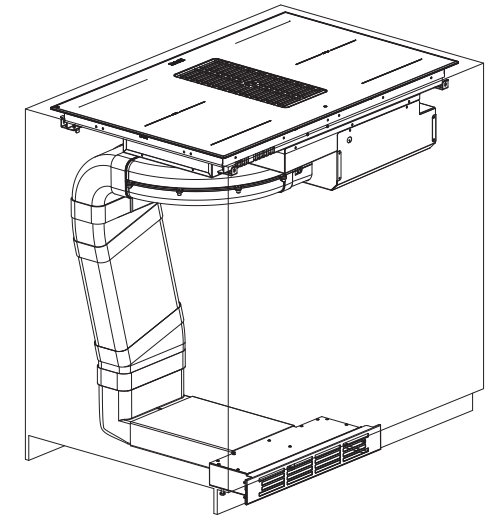

A700 D77 - Filter kit for pedestal H6/8 cm € 850

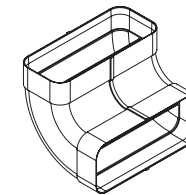

A700 D35 € 92
15° angular connection
vertical section 227 x 94 mm
dimensions 174 x 174 x 227 mm

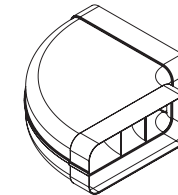

A700 D34 € 92
90° angular connection
horizontal section 227 x 94 mm
dimensions 288 x 288 x 94 mm

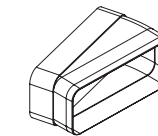

A700 D36 € 52
15° angular connection
section 227 x 94 mm
dimensions 233 x 138 x 94 mm

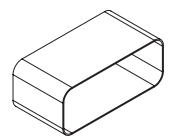

A700 D33 € 52
Angular connection
section 227 x 94 mm
dimensions 227 x 94 x 80 mm

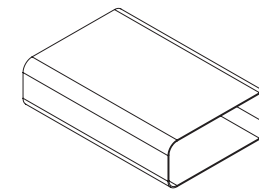

A700 D32 € 100
Rectangular tube
section 222 x 89 mm
dimensions 222 x 89 x 1000 mm

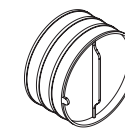

A700 D38 € 250
Non-return valve
section ronde Ø 148 mm

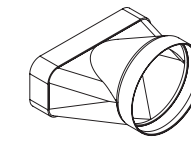

A700 D37 € 81
multi-section rectangular adapter
227 x 94 mm round Ø 148 mm
dimensions 190 x 150 x 227 mm

TRIO

COMFORT IN SMALL SPACES

The three-zone hob ensures maximum ease of use even in small spaces, thanks to its compact dimensions. The 4 mm thick black ceramic glass hob is characterised by the radius of the corners and the silk-screen printed circles that highlight the three cooking zones.

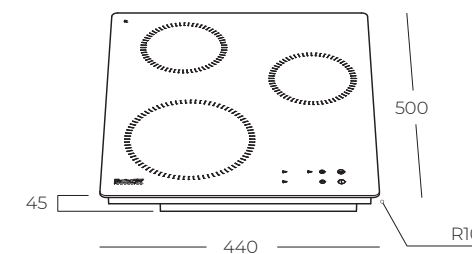
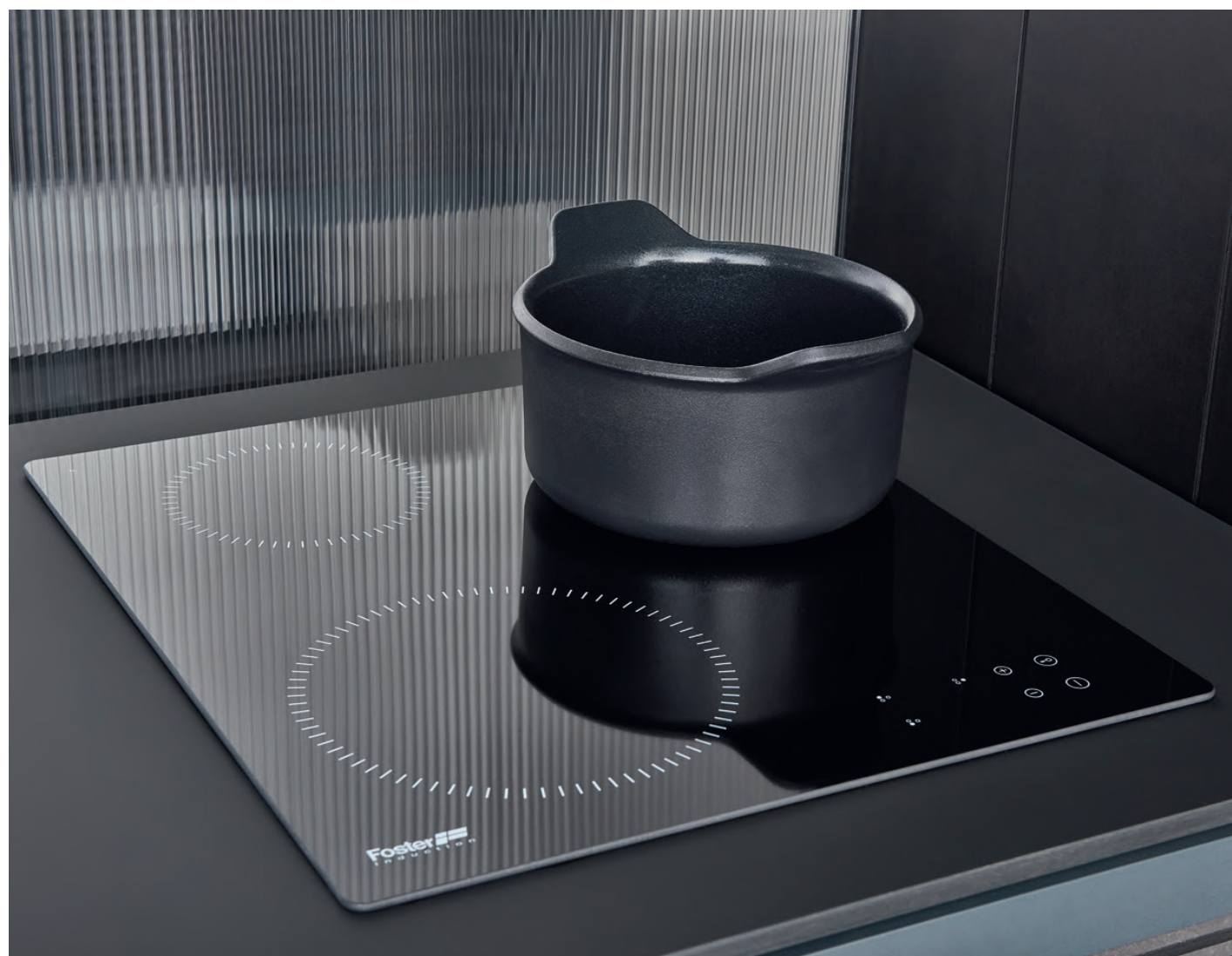

TM | cut-out for Top mount

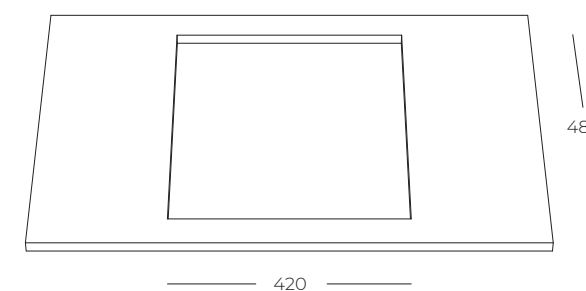

FT | cut-out for Flush-mount

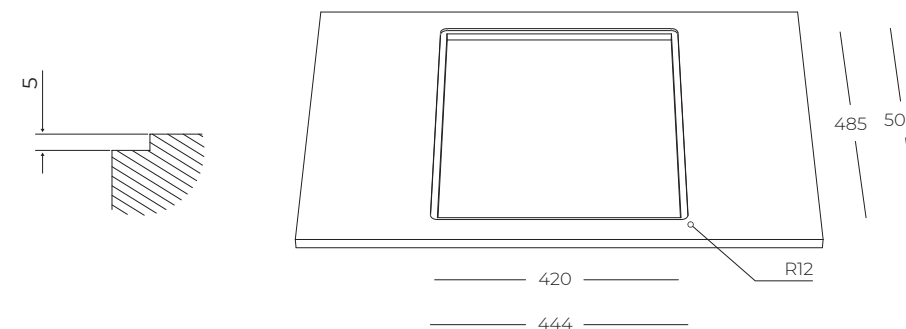

TRIO
I373 C00 € 899
cooking system

4 mm thick black glass ceramic induction plate with bevelled edge. 3 round cooking zones with white serigraphy. Top or flush installation.

Recommended installation base 60 cm
Maximum dimensions 500 x 440 x h 45 mm
Single-phase power supply 230 V - 1P+N
Two-phase power supply 400 V - 2P+N
Frequency 50/60 Hz

Electronic programming of the cooking zones with Touch technology and Slider control
9 power settings per zone plus Powerboost function
2 cooking zones Ø 145 mm - 1,200 (1,600)* W
1 cooking zone Ø 240 mm - 1,500 (2,000)* W
Total power 5,200* W
Power limit function

*Powerboost

